

# OUTLINE DIMENSIONAL DRAWING

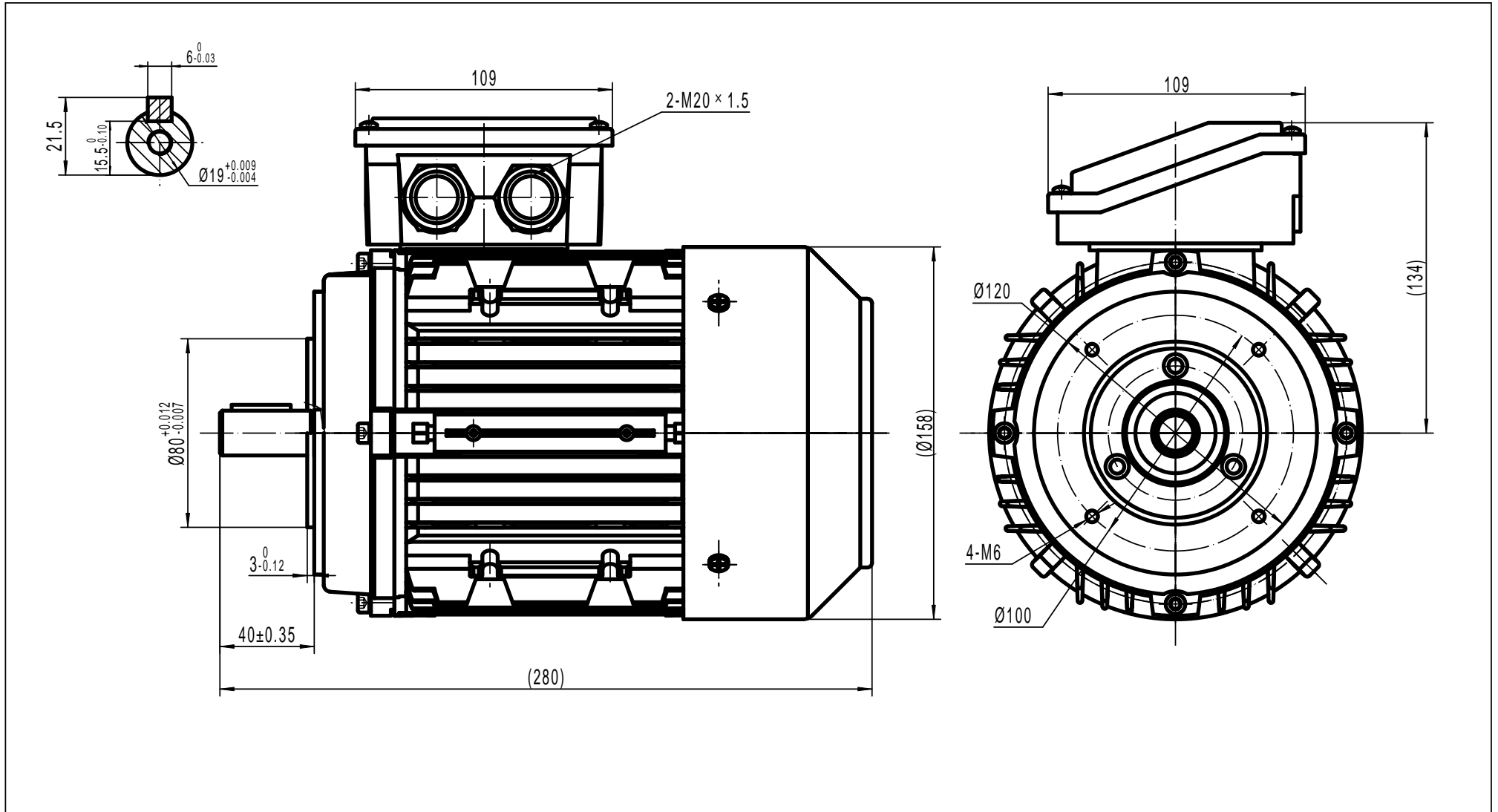

TECHTOP AUSTRALIA PTY LTD	
FRAME	TAI 80A B14
DATE	DRAWING NO.
2011/10/14	1ST083.060.001-020 A